



FERPLAC
D O O R S



**COLLEZIONE
LAMINATI**
PRINT 15



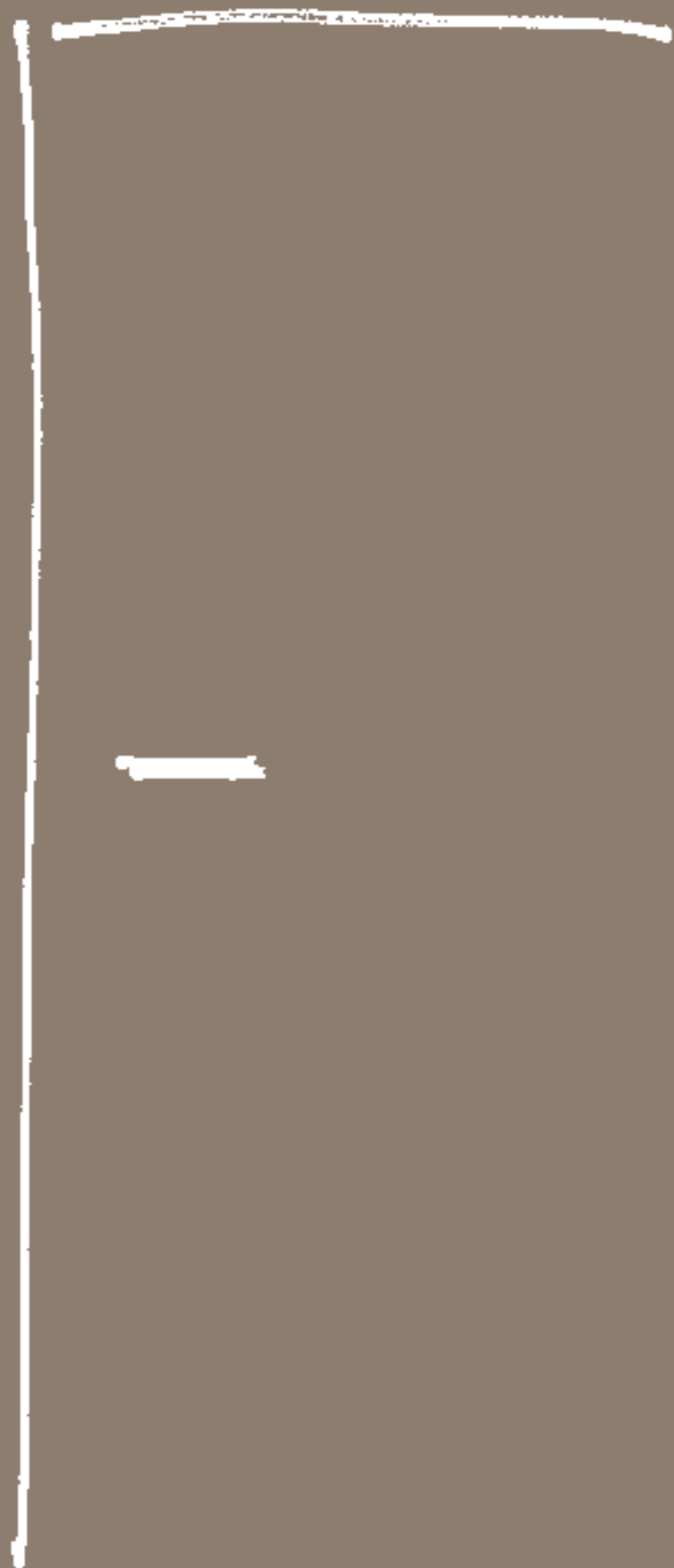

LA QUALITÀ
SOTTO OGNI
PROFILO



QUANDO
L'**EVOLUZIONE**
E IL **DESIGN**
INCONTRANO
LA NATURA



Ferplac Doors evolve la propria gamma presentando due linee di prodotti in laminato: **Print15**, la gamma base, e la sua evoluzione, **Print Evo18**.

L'innovativa **Print Evo18** è il risultato di una lunga ricerca che risponde alle caratteristiche di resistenza, estetica, stabilità nel tempo ed emozione tattile.

Tutte le finiture applicate ai modelli **Print15** e **Print Evo18**, impiegano pellicole nobilitate effetto legno dal design moderno.

LA NOVITÀ FATTA PER ESSERE **ACCAREZZATA**



Porte dai materiali adatti ad ambienti dinamici, facili da abbinare ed utili per completare la propria casa con soluzioni innovative che rappresentano veri e propri elementi di design.

L'estrema matericità delle superfici è il valore aggiunto delle serie Print15 e Print Evo18. Un piacere alla vista e al tatto ai quali ritorna la sensazione ed il piacere di un materiale vivo e naturale, duraturo e solido nel tempo.



I DETTAGLI CHE FANNO LA DIFFERENZA



Lo scheletro della porta viene realizzato in robusto e spesso listellare a cinque strati; il bordo, dello stesso materiale del decoro di facciata. Gli spigoli sono dolcemente arrotondati al pari di quanto avviene già nel legno e gli stipiti sono a loro volta realizzati in robusto listellare a cinque strati.

La scelta della ferramenta, con cerniere a scomparsa e le serrature magnetiche, prodotte dalle aziende più rinomate, esaltano e danno pregio al prodotto, oltre che garanzia di qualità e funzionalità.

LO STILE
INNOVATIVO
DELLA
COLLEZIONE
PRINT 15



PRINT 15

BIANCO SPAZZOLATO | 098L

Di colore bianco con superficie spazzolata che dona carattere giovane e "graffiante".
Adatta allo stile moderno e casual.



PRINT 15 | BIANCO SPAZZOLATO | 098L



PRINT 15

BIANCO LISCIO | i68

La finitura bianca liscia dona
semplicità ed eleganza;
conferendo luminosità
e una linea discreta.
Adatta a tutti gli ambienti
e a tutti i gusti.



PRINT 15 | BIANCO LISCIO | i68



PRINT 15

LARICE SPAZZOLATO | i66

La trama riproduce il larice con effetto segato positivo; è un decoro che esprime resistenza e durezza al pari del legno dal quale si ispira.



PRINT 15 | LARICE SPAZZOLATO | i66



LA GAMMA PRINT 15

Rappresenta la gamma base delle porte in laminato che Ferplac Doors propone; la serie Print15 è stata configurata per assicurare un giusto equilibrio tra prezzo e qualità: la **struttura** della porta è realizzata in abete, gli **stipiti** di abete monostrato e le **cornici** in multistrato.

Le porte sono disponibili a magazzino già ferramentate per cerniere anuba e serratura patent, mentre per cerniere a scomparsa e serratura magnetica, la ferramenta viene montata al bisogno.

PORTE FERRAMENTATE cerniere anuba

PORTE CIECHE BATTENTI FERRAMENTATE (cerniere anuba e serratura patent)

ART. 098L	ART. i68	ART. i66	LARGHEZZA "Luce max"	ALTEZZA "Luce max"
17900/700	17980/700	17885/700	700	2100
17900/750	17980/750	17885/750	750	2100
17900/800	17980/800	17885/800	800	2100
17900/900	17980/900	17885/900	900	2100

Nota: su richiesta le porte possono essere fornite anche ferramentate per cerniere a scomparsa e serratura magnetica.

PORTE CIECHE SCORREVOLI FERRAMENTATE

ART. 098L	ART. i68	ART. i66	LARGHEZZA "Luce max"	ALTEZZA "Luce max"
17900/700S	17980/700S	17885/700S	700	2100
17900/750S	17980/750S	17885/750S	750	2100
17900/800S	17980/800S	17885/800S	800	2100
17900/900S	17980/900S	17885/900S	900	2100

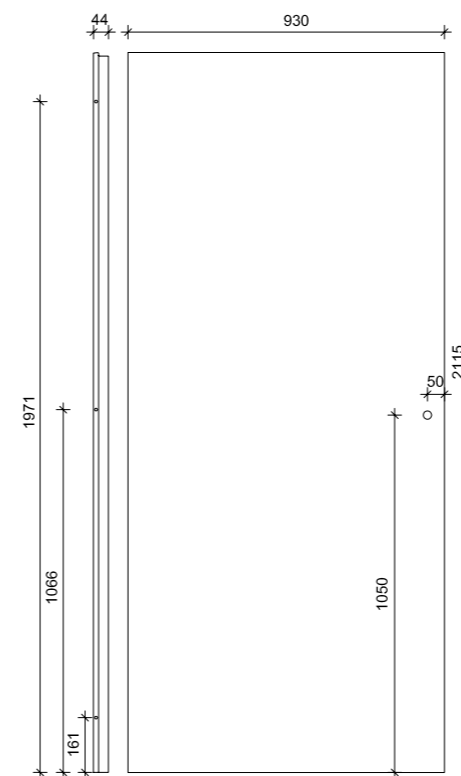

Porte cieche battenti ferramentate

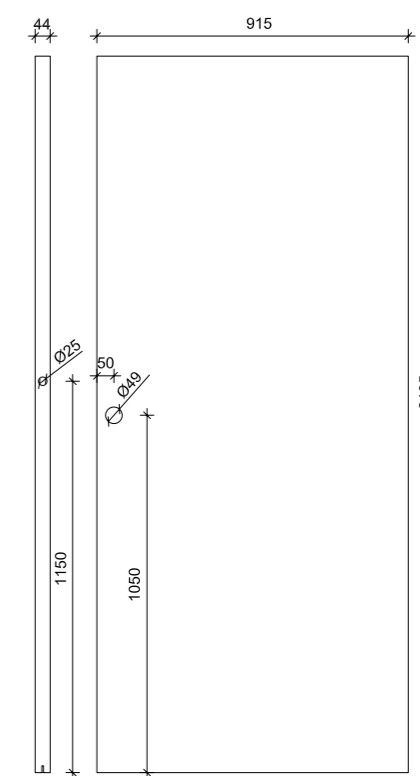

Porte cieche scorrevoli ferramentate

STIPITI FERRAMENTATI cerniere anuba

SET STIPITI FERRAMENTATI (cerniere anuba) - battuta 32

ART. 098L	ART. i68	ART. i66	SP. STIPITE	DA SP. MURO	A SP. MURO	ALTEZZA "Luce max"
17901	17981	17886	110	105	125	2100
17902	17982	17887	130	126	145	2100
17903	17983	17888	150	146	165	2100

Nota: il set è composto da una coppia montanti più un trasverso.

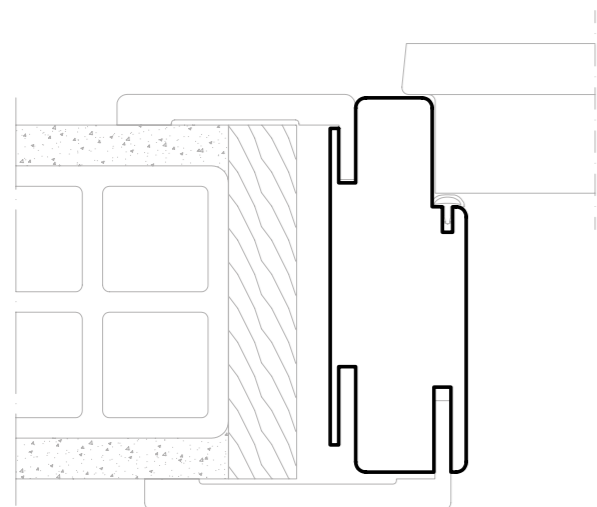
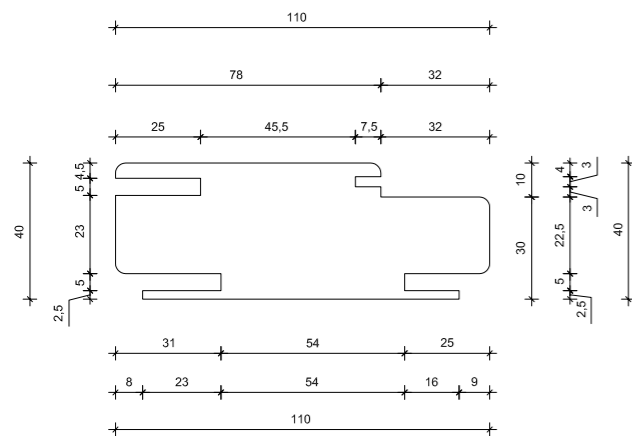

PORTE NON FERRAMENTATE

PORTE CIECHE CON BATTUTA

ART. 098L	ART. i68	ART. i66	LARGHEZZA "Luce max"	ALTEZZA "Luce max"
17826/700	17950/700	17844/700	700	2100
17826/750	17950/750	17844/750	750	2100
17826/800	17950/800	17844/800	800	2100
17826/900	17950/900	17844/900	900	2100
17826/1000	-	-	1000	2100

PORTE CIECHE SENZA BATTUTA

ART. 098L	ART. i68	ART. i66	LARGHEZZA "Luce max"	ALTEZZA "Luce max"
17826/700S	17950/700S	17844/700S	700	2100
17826/750S	17950/750S	17844/750S	750	2100
17826/800S	17950/800S	17844/800S	800	2100
17826/900S	17950/900S	17844/900S	900	2100
17826/1000S	-	-	1000	2100

Nota: ante per porte scorrevoli o battenti con cerniere a scomparsa.

STIPITI NON FERRAMENTATI per porte battenti

STIPITI NON FERRAMENTATI (cerniere anuba) - battuta 32

ART. 098L	ART. i68	ART. i66	SP. STIPITE	DA SP. MURO	A SP. MURO	ALTEZZA
17828	17953	17848	110	105	125	2170
17829	17954	17849	130	126	145	2170
17830	17955	17850	150	146	165	2170

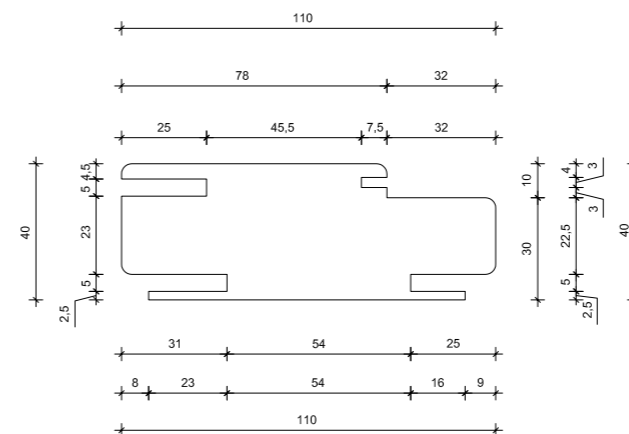

STIPITI NON FERAMENTATI (per cerniere a scomparsa) - battuta 49

ART. 098L	ART. i68	ART. i66	SP. MURO	DA SP. MURO	A SP. MURO	ALTEZZA
17831S	17956	17851	110	105	125	2170
17832S	17957	17852	130	126	145	2170
17833S	17958	17853	150	146	165	2170

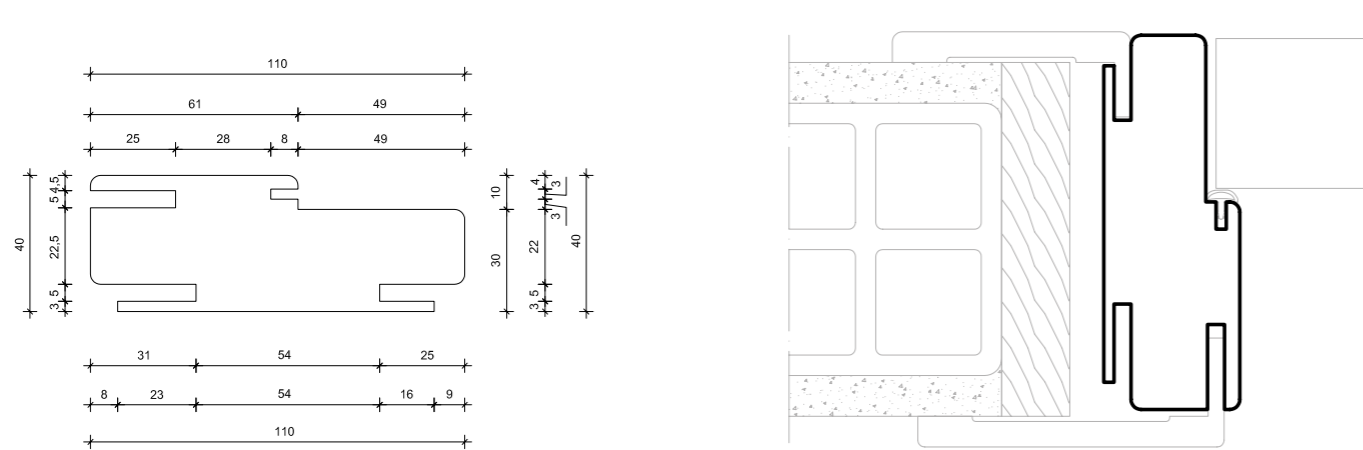

STIPITI PER SCORREVOLI A SCOMPARSA (BINO'S) - Intonaco

ART. 098L	ART. i68	ART. i66	LARGHEZZA "Luce max"	ALTEZZA "Luce max"	SP. MURO
17904S	17984S	17889	1050	2100	108
17905S	17985S	17890	1050	2100	125
17906S	17986S	17891	1050	2100	150

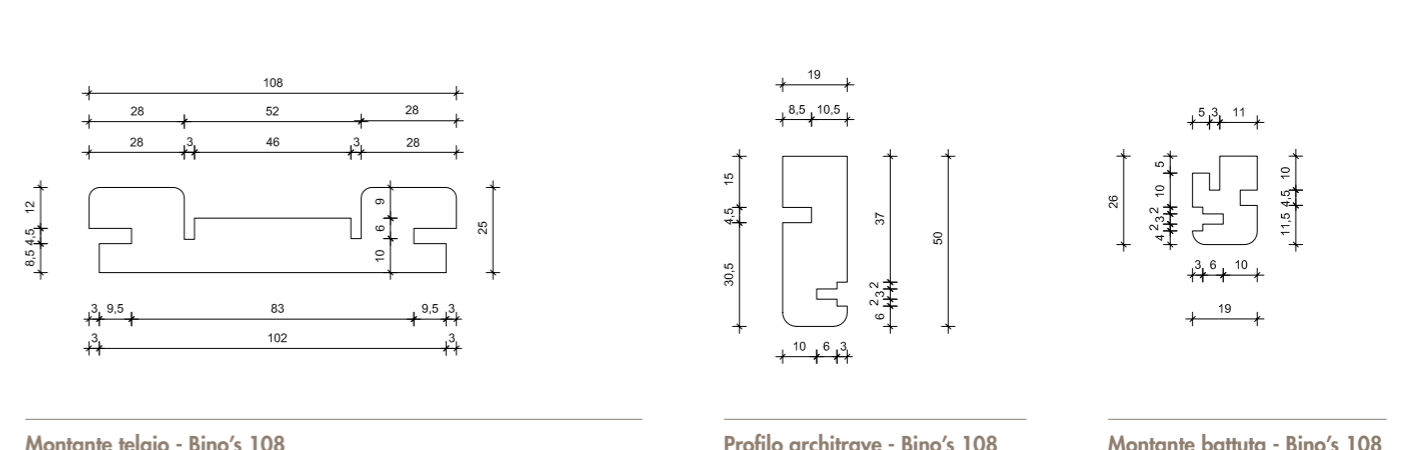

STIPITI NON FERRAMENTATI per porte scorrevoli interne

STIPITI PER SCORREVOLI A SCOMPARSA (BINO'S) - Cartongesso

ART. 098L	ART. i68	ART. i66	LARGHEZZA "Luce max"	ALTEZZA "Luce max"	SP. MURO
18361	18362	-	1050	2100	100

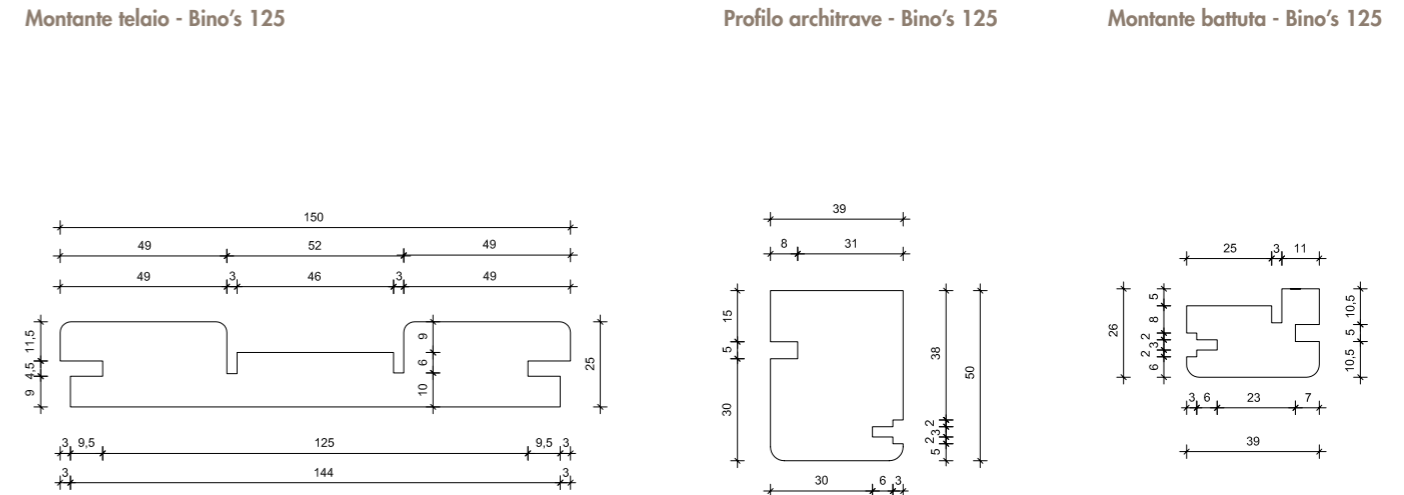
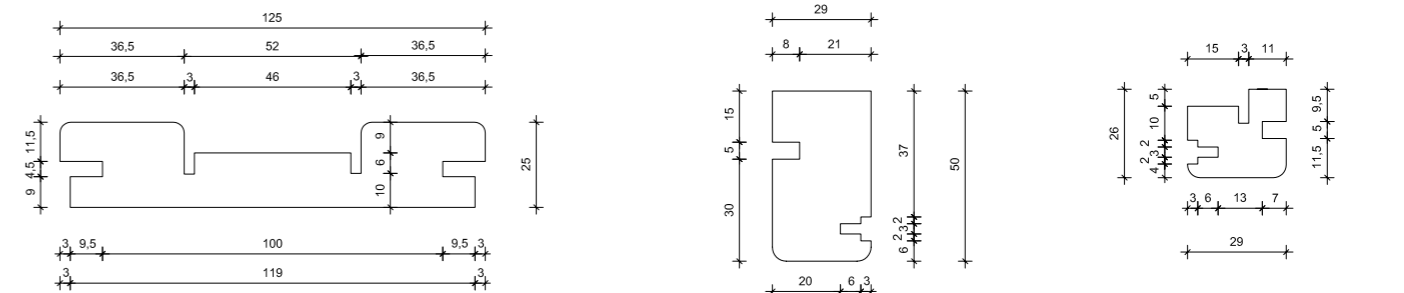
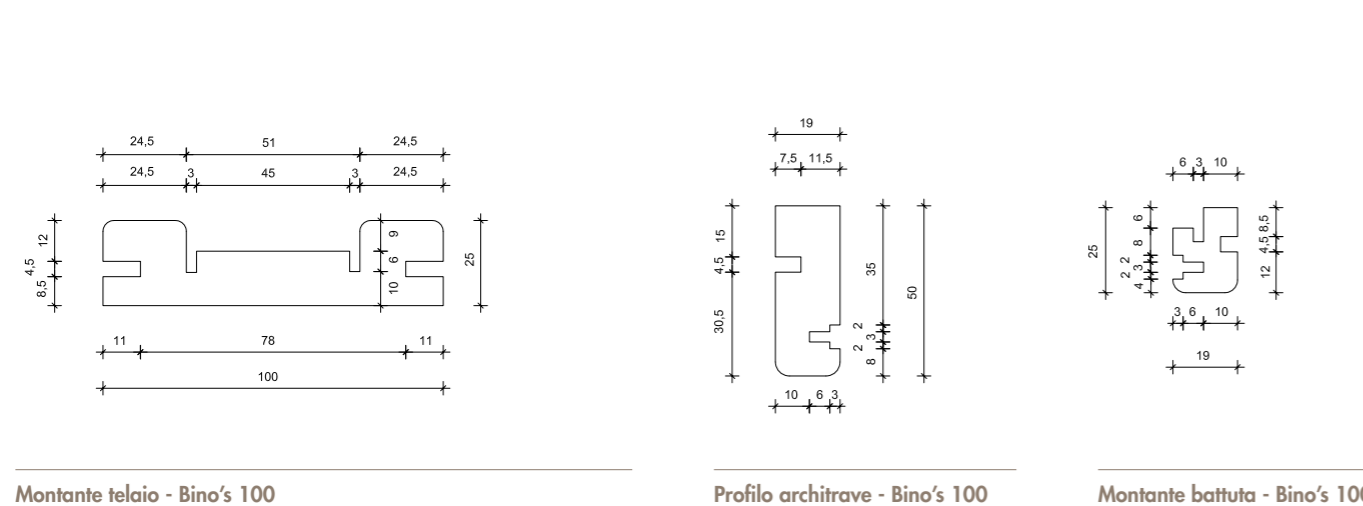

Montante telaio - Bino's 100

Profilo architrave - Bino's 100

Montante battuta - Bino's 100

Montante telaio - Bino's 125

Profilo architrave - Bino's 125

Montante battuta - Bino's 125

Montante telaio - Bino's 150

Profilo architrave - Bino's 150

Montante battuta - Bino's 150

ALTRI STIPITI E ALLARGATORI NON FERRAMENTATI

STIPITI A GIORNO

ART. 098L	ART. i68	ART. i66	SP. STIPITE	DA SP. MURO	A SP. MURO	ALTEZZA
17936	17972	17937	110	105	125	2170

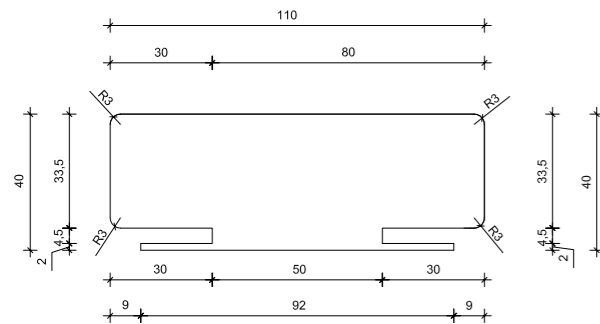

ALLARGATORI

ART. 098L	ART. i68	ART. i66	LARGHEZZA	ALTEZZA	SPESSORE
17837	17959	17857	235	2200	12

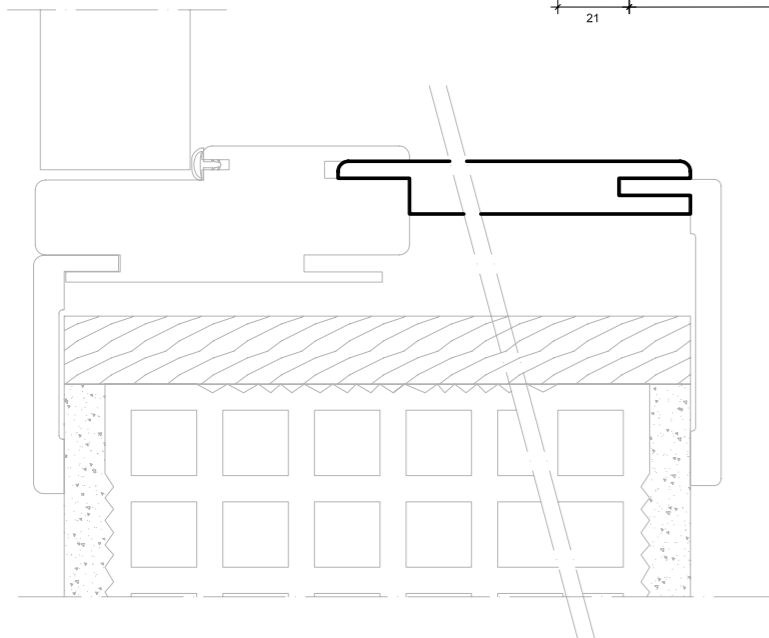
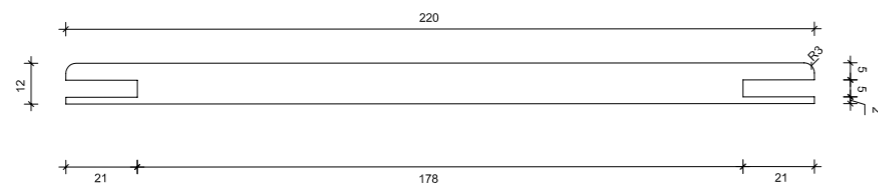

BATTUTA PER TRAVERSO DI PORTA PIEGHEVOLE COMPACT

ART. 098L	ART. i68	ART. i66	SP. MURO	DA SP. MURO	A SP. MURO	ALTEZZA
18358	18357	-	110	105	125	2170

Nota: Disegni esempio di porta pieghevole compact a pag. 63

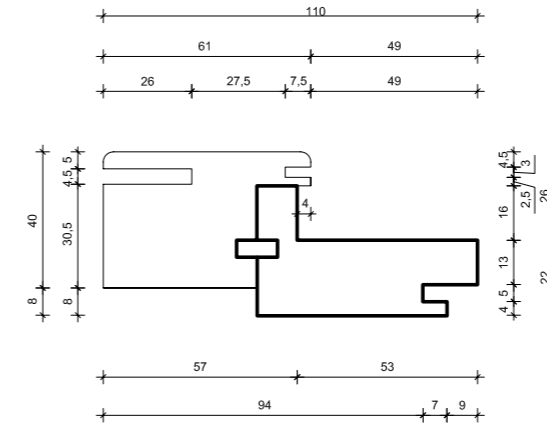

CORNICI

CORNICI CON ALA (UNI)

ART. 098L	ART. i68	ART. i66	LARGHEZZA	ALTEZZA	ALA
17839S	17960S	17859	70	2250	25
17876S	17961S	17878	70	3050	25
17840S	17962S	17860	90	2250	25
17877S	17963S	17879	90	3050	25

CORNICI CON ALA LUNGA (UNI)

ART. 098L	ART. i68	ART. i66	LARGHEZZA	ALTEZZA	ALA
18049	18048	-	90	2250	61

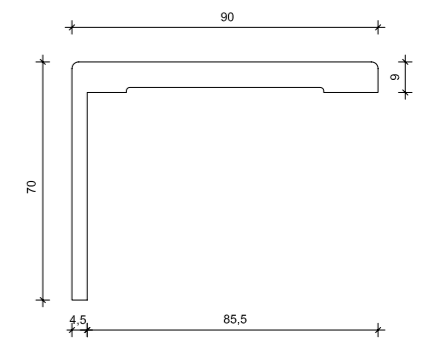
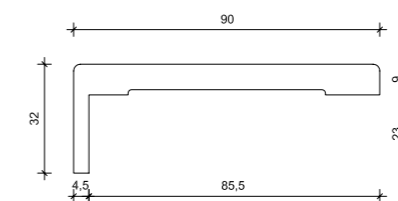
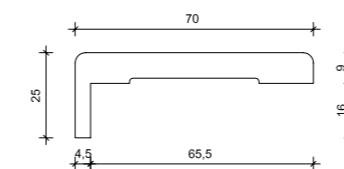

Cornici con ala (UNI)

Cornici con ala lunga (UNI)

FERMAVETRO

FERMAVETRO

ART. 098L	ART. i68	ART. i66	ALTEZZA	BATTUTA
17841S	17964S	17861	2400	19

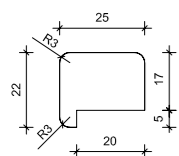

PROFILI per porte ad anta doppia

PROFILO DI CONGIUNZIONE PER ANTA DOPPIA SCORREVOLE

ART. 098L	ART. i68	ART. i66	ALTEZZA	TIPO
17940	17974	17941	2170	Maschio
17938	17973	17939	2170	Femmina

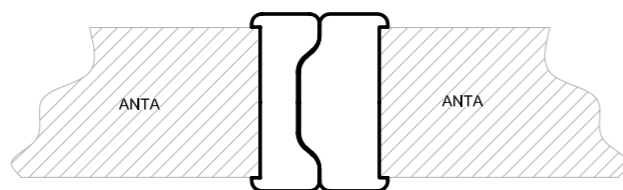
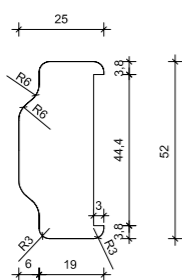
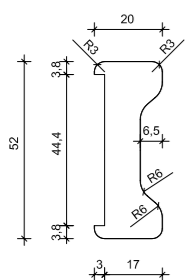

SCAMBIO BATTUTA PER ANTA DOPPIA BATTENTE

ART. 098L	ART. i68	ART. i66	ALTEZZA
17992	17994	17993	2170

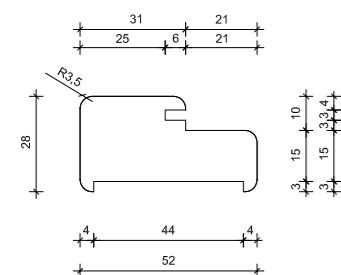

ELEMENTI per porte scorrevoli esterno muro

BATTIPORTA PER SCORREVOLE ESTERNO

ART. 098L	ART. i68	ART. i66	ALTEZZA
17943	17976	17947	2170

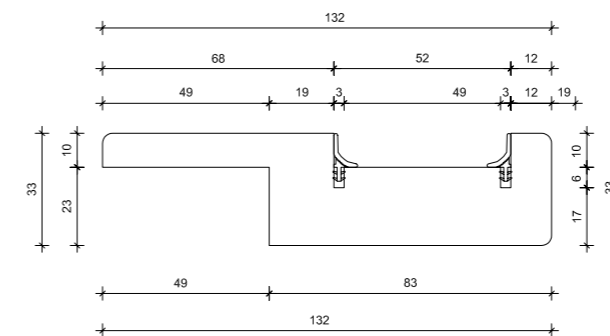

PORTASPAZZOLINO PER SCORREVOLE ESTERNO

ART. 098L	ART. i68	ART. i66	ALTEZZA
17944	17977	17948	2200

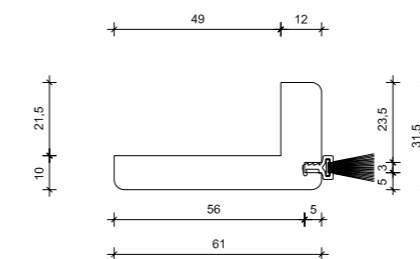

MANTOVANA PER SCORREVOLE ESTERNO

ART. 098L	ART. i68	ART. i66	LUNGHEZZA	ALTEZZA
17942	17975	17946	2400	102

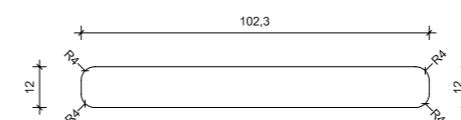

COMPONENTI per portoni blindati

PANNELLI DI RIVESTIMENTO DI PORTONI BLINDATI (LATO INTERNO)

ART. 098L	ART. i68	ART. i66	LARGHEZZA	ALTEZZA	SPESSORE
17827	17951	17845	1050	2150	6
17907	17952	17908	1050	3100	4

IMBRAVATURE PER BLINDATI

ART. 098L	ART. i68	ART. i66	ALTEZZA	LATO	LATO
17842	17969	17847	2200	21	36

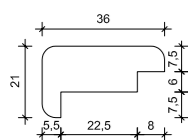

ALTRI PROFILI

BATTISCOPIA

ART. 098L	ART. i68	ART. i66	ALTEZZA	LUNGHEZZA	SPESSORE
178435	179715	17846	70	2400	9,2

PARASPIGOLO LISCIO

ART. 098L	ART. i68	ART. i66	ALTEZZA	LATO	LATO
17909	17970	17931	3000	30	30

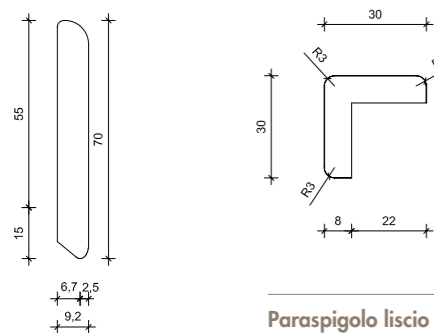

PRINT EVO18



R69



T82



F44

PRINT 15



098L



i68



i66

KIT FERRAMENTA

PRINT EVO18

PRINT 15



Cerniere a scomparsa e le serrature magnetiche, prodotte dalle aziende più rinomate nel mondo, esaltano e danno pregio al prodotto, oltre che garanzia di qualità e funzionalità.

CERNIERE

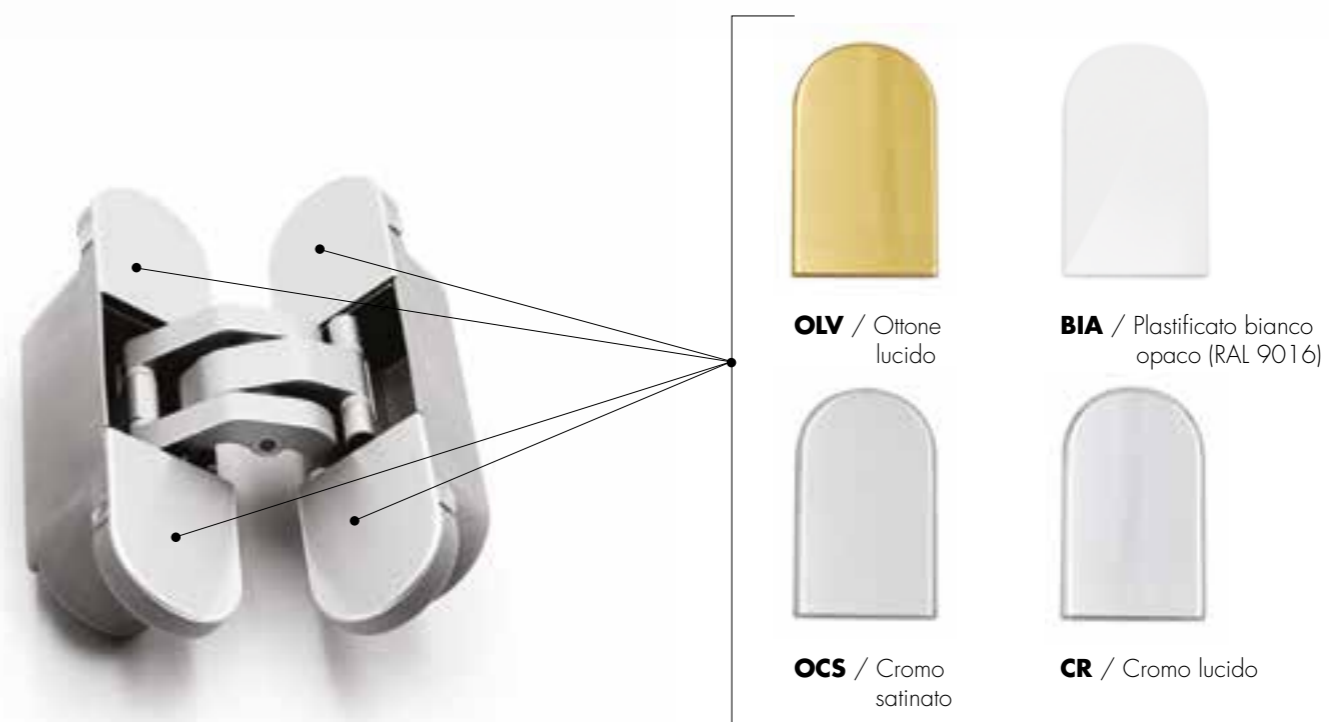

KIT FERRAMENTA per porte con cerniere a scomparsa Special

ARTICOLO	FINITURA	ARTICOLO	FINITURA
18190	KIT CROMO SATINATO	18192	KIT OTTONE LUCIDO
18191	KIT CROMO LUCIDO	18193	KIT BIANCO

Nota: Tutti i kit sono composti da 2 cerniere, rostro centrale, serratura magnetica, riscontro e set viti di fissaggio.

SERRATURE



OLV / Ottone lucido



OCS / Cromo satinato



KIT FERRAMENTA per porte scorrevoli interne

ARTICOLO	FINITURA	ARTICOLO	FINITURA
17248	KIT CROMO SATINATO	17325	KIT OTTONE LUCIDO
17257	KIT CROMO SATINATO maniglia	17326	KIT OTTONE LUCIDO maniglia

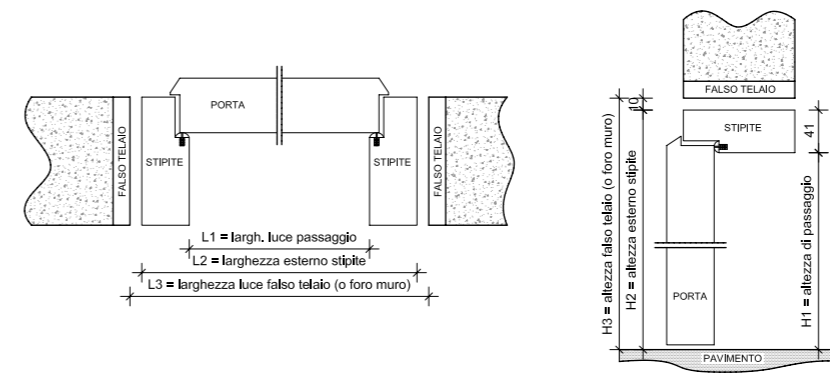

PORTA BATTENTE MONTATA SU PARETE IN MURATURA
sezione verticale e orizzontale

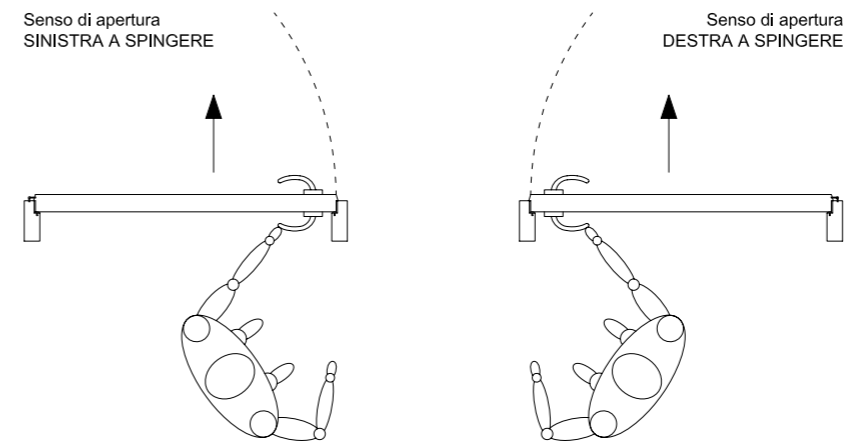

SENSO DI APERTURA PORTE
sezione verticale e orizzontale

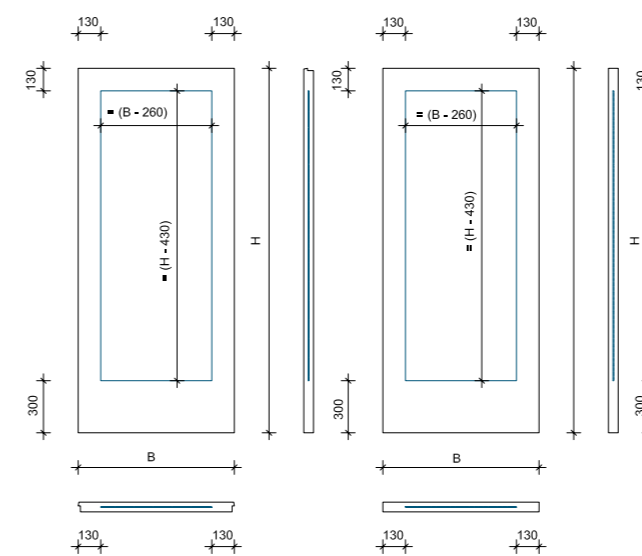

Dimensioni foro vetro porta standard

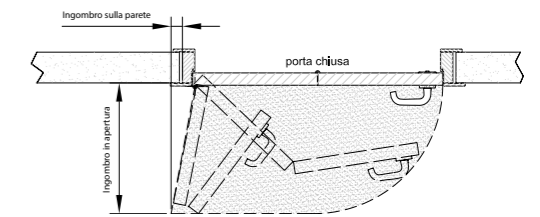

Schema porta Compack 90° - esempio di porta SX

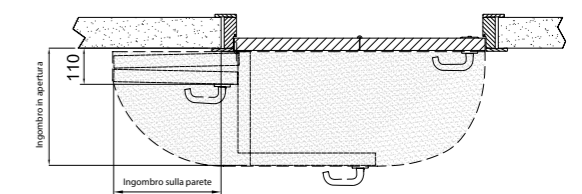

Schema porta Compack 180° - esempio di porta SX



Ferplac SpA

Via Santa Giustina 16/A
36028 Rossano Veneto
Vicenza - Italia

T +39 0424 540465
F +39 0424 540373
info@ferplac.it

ferplac.it



© 2018 Ferplac SPA
Tutti i diritti riservati

MADE BY PALAZZINACREATIVA.IT



ferplac.it